





# PRODUCT CATALOG

-  [contact@hitchworksusa.com](mailto:contact@hitchworksusa.com)
-  +1-308-325-0371
-  [www.hitchworksusa.com](http://www.hitchworksusa.com)



## TRAILER PARTS AND ACCESSORIES





## Hitchworks

Hitchworks is a U.S.-based partner specializing in custom-manufacturing, assembly and fulfillment solutions that help manufacturers elevate output and reduce costs.



**TRAILER  
COUPLER**

03-12



**TRAILER  
JACK**

13-22



**BALL  
MOUNT**

23-29



**WINCHES**

30-32



**SAFETY  
CHAIN**

33-35



**TRAILER  
HITCH BALL**

36-37



**TOWING  
LIGHTS**

38-39



**SPARE TIRE  
CARRIER**

40-41



**COVER**

40-41



# TRAILER COUPLER

The trailer coupler is the foremost part of the trailer, which is used to connect the hook of the tractor to the trailer. According to the required bearing capacity, we need to choose a trailer coupler of suitable size and style to use. The coupler size must match the size of the trailer ball.



# Straight Coupler



## PRODUCT INDEX



**04**  
STRAIGHT  
COUPLER



**05-06**  
A-FRAME  
COUPLER



**07**  
ADJUSTABLE  
COUPLER



**08**  
OTHER  
COUPLER



**09**  
GOOSENECK  
COUPLER



**10**  
EUROPEAN  
COUPLER



**10**  
AUSTRALIAN  
COUPLER



**11**  
LUNETTE  
RING



**11**  
CHANNEL  
BRACKET



**12**  
OTHER COUPLER  
ACCESSORIES

JY NO.	Ball Size	Channel Size	Capacity	SAE	Finished
1BJY-TC-01	1-7/8"	2"	2000LBS	Class I	Zinc/Black/Oil
1BJY-TC-02	1-7/8"	2-1/2"	2000LBS	Class I	Zinc/Black/Oil
1BJY-TC-03	1-7/8"	3"	2000LBS	Class I	Zinc/Black/Oil
1BJY-TC-04	2"	2"	3500LBS	Class II	Zinc/Black/Oil
1BJY-TC-05	2"	2-1/2"	3500LBS	Class II	Zinc/Black/Oil
1BJY-TC-06	2"	3"	3500LBS	Class II	Zinc/Black/Oil
1BJY-TC-07	2"	3"	5000LBS	Class III	Zinc/Black/Oil





# A-Frame Coupler



1BJY-TC-08

1BJY-TC-09

1BJY-TC-10  
1BJY-TC-11

1BJY-TC-13  
1BJY-TC-14

1BJY-TC-19  
1BJY-TC-20

JY NO.	Ball Size	Capacity	SAE/CSA	Finished
1BJY-TC-08	2"	5000LBS	Class III	Black/Zinc/Oil
1BJY-TC-09	2"	5000LBS	Class III	Black/Zinc/Oil
1BJY-TC-10	2"	7000LBS	Class IV	Black/Zinc/Oil
1BJY-TC-11	2-5/16"	12500LBS	Class IV	Black/Zinc/Oil
1BJY-TC-13	2-5/16"	10000LBS	Class IV	Black/Zinc/Oil
1BJY-TC-14	2-5/16"	14000LBS	Class IV	Black/Zinc/Oil
1BJY-TC-19	2"	5000LBS	Class III	Black/Zinc/Oil
1BJY-TC-20	2"	8000LBS	Class IV	Black/Zinc/Oil



# A-Frame Coupler



NEW

1BJY-TC-42B

- Ball size: 2-5/16"
- Capacity: 15000LBS
- Jack hole diameter: 2-3/8"
- Pin hole diameter: 5/16"
- Overall dimensions: 17-1/2" long x 10-3/4" wide



NEW

1BJY-TC-45B / 1BJY-TC-46B

- Ball size: 2" / 2-5/16"
- Capacity: 10000LBS / 15000LBS
- Jack hole diameter: 2-3/8"
- Lock pin hole diameter: 3/8"
- Length: 18"



1BJY-TB-01

- Coupler ball: 2"
- Arm extend: 26"-41"
- Capacity: 5000LBS





# Adjustable Coupler



1BJY-TC-12



1BJY-TC-15  
1BJY-TC-16



1BJY-TC-17  
1BJY-TC-18



1BJY-TC-25  
1BJY-TC-26

JY NO.	Ball Size	Finished	Capacity	SAE
1BJY-TC-12	2-5/16"	Black/Zinc/Oil	15000LBS	Class IV
1BJY-TC-15	2"	Black/Zinc/Oil	7000LBS	Class IV
1BJY-TC-16	2-5/16"	Black/Zinc/Oil	12500LBS	Class IV
1BJY-TC-17	2"	Black/Zinc/Oil	8000LBS	Class IV
1BJY-TC-18	2-5/16"	Black/Zinc/Oil	14000LBS	Class IV
1BJY-TC-25	2"	Black/Zinc/Oil	10000LBS	Class IV
1BJY-TC-26	2-5/16"	Black/Zinc/Oil	15000LBS	Class IV

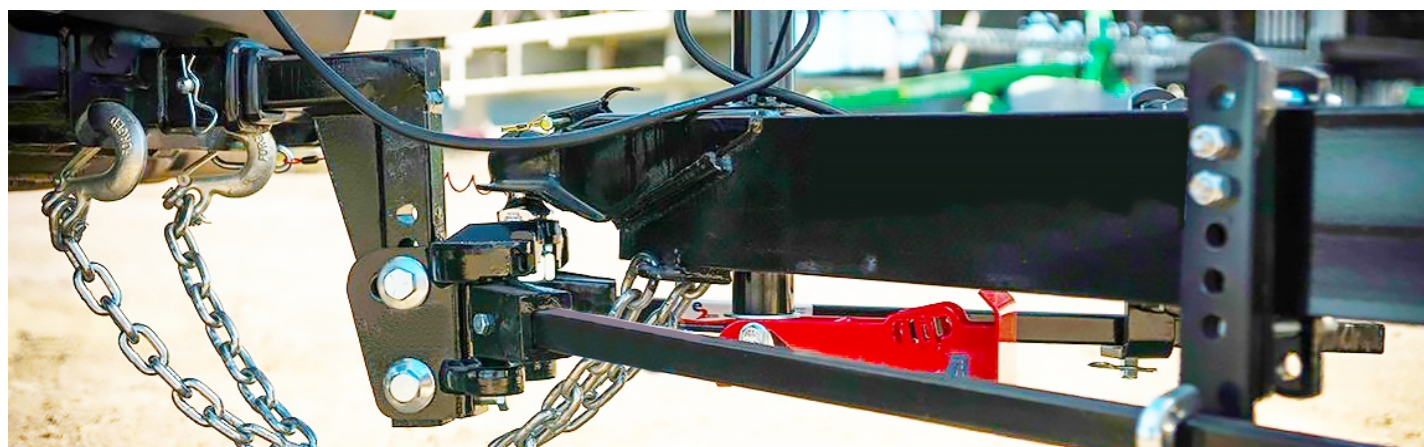

# Other Coupler



1BJY-TC-25T  
1BJY-TC-26T



1BJY-TC-29  
1BJY-TC-30



1BJY-TC-47  
1BJY-TC-48

JY NO.	Ball Size	Capacity	Finished	Bolt
1BJY-TC-25T	2"	10000LBS	Black/Zinc/Oil	/
1BJY-TC-26T	2-5/16"	15000LBS	Black/Zinc/Oil	/
1BJY-TC-29	2"	8000LBS	Black/Zinc/Oil	with/without
1BJY-TC-30	2-5/16"	14000LBS	Black/Zinc/Oil	with/without
1BJY-TC-47	2"	7500LBS	Black/Zinc/Oil	/
1BJY-TC-48	2-5/16"	10000LBS	Black/Zinc/Oil	/

## 1BJY-TC-40

NEW

- Gross towing weight:20000LBS
- Tongue weight:2000LBS
- Capacity:14000LBS
- Vertical channel:3-1/2"x11-3/4" w/2"
- Outer front width:4"
- Outer rear width:11"
- Front-to-back length:7-1/2"
- Equipped with 6 Adjustment Holes
- Welding status: Spare parts/Welding parts



## 1BJY-TC-41

NEW

- Gross towing weight:20000LBS
- Tongue weight:2000LBS
- Capacity:14000LBS
- Vertical channel:3-1/2"
- Outer front width:4"
- Outer rear width:11"
- Front-to-back length:7-1/2"
- Equipped with 6 Adjustment Holes



# Gooseneck Coupler



## 1BJY-TC-21

- **Ball size:** 2-5/16"
- **Capacity:** 30000LBS
- **Finished:** Black/Oil



## 1BJY-TC-22

- **Ball size:** 2-5/16"
- **Capacity:** 25000LBS
- **Finished:** Black/Oil



## 1BJY-TC-23

- **Ball size:** 2-5/16"
- **Range of vertical adjustment:** 7"
- **Capacity:** 30000LBS
- **Finished:** Black/Oil



# European Coupler



1BJY-E01  
1BJY-E02



JY NO.	Ball Size	Channel Size	Capacity	Finished
1BJY-E01	50mm	50mm	3500LBS	Zinc
1BJY-E02	50mm	60mm	3500LBS	Zinc

# Australian Coupler



1BJY-A01

1BJY-A03

1BJY-A05

JY NO.	Hitch Ball	Capacity	Hole	Finished
1BJY-A01	50mm	2500KG	2 Holes	Zinc
1BJY-A02	50mm	2500KG	3 Holes	Zinc
1BJY-A03	50mm	2500KG	4 Holes	Zinc
1BJY-A04	50mm	2000KG	/	Zinc
1BJY-A05	50mm	3500KG	/	Zinc



# Lunette Ring



1BJY-PR-01  
1BJY-PR-02



1BJY-CK-04

JY NO.	Capacity	Finished
1BJY-PR-01	14000LBS	Oil/Black
1BJY-PR-02	24000LBS	Oil/Black
1BJY-CK-04/1BJY-CK-06	14000LBS	Oil/Black

# Channel Bracket



1BJY-CP-06



1BJY-CK-02

JY NO.	Hole	Capacity	Position	Finished
1BJY-CP-04	4 Holes	13000LBS	3-Position Channel	Oil/Black
1BJY-CP-06	6 Holes	15000LBS	5-Position Channel	Oil/Black

JY NO.	Trailer Coupler	Channel Bracket	Finished
1BJY-CK-02	2-5/16" Ball Size, 15000LBS Capacity(1BJY-TC-12)	4 Hole, 3-Position Channel(1BJY-CP-04)	Oil/Black

# Other Coupler Accessories



## Coupler Handle



1BJY-CL-01  
1BJY-CL-02  
1BJY-CL-03

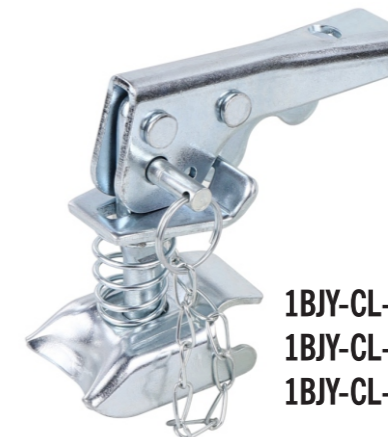

1BJY-CL-04  
1BJY-CL-05  
1BJY-CL-06



1BJY-TCH-01

## Safety Pin



1BJY-LP-01



1BJY-LP-02



1BJY-LP-03

JY NO.	Product Detail	Capacity	Finished
1BJY-CL-01	Repair Kit for 1-7/8" Ball Straight Channel Couplers	2000LBS	Zinc
1BJY-CL-02	Repair Kit for 2" Ball Straight Channel Couplers	3500LBS	Zinc
1BJY-CL-03	Repair Kit for 2" Ball Straight Channel Couplers	5000LBS	Zinc
1BJY-CL-04	Repair Kit for 1-7/8" Ball Straight Channel Couplers with Chain	2000LBS	Zinc
1BJY-CL-05	Repair Kit for 2" Ball Straight Channel Couplers with Chain	3500LBS	Zinc
1BJY-CL-06	Repair Kit for 2" Ball Straight Channel Couplers with Chain	5000LBS	Zinc

JY NO.	Product Detail	Finished
1BJY-TCH-01	Fits 1-7/8" and 2" couplers	Zinc
1BJY-LP-01	Pin with steel ball	Zinc
1BJY-LP-02	Φ6 Snapper Pin for Jack Foot, Caster Wheel and Couplers	Zinc
1BJY-LP-03	Pin for 7K and 12.5K Sleeve Lock Couplers	Zinc





# TRAILER JACK

Trailer jacks or tongue jacks, are used to raise and stabilize a trailer so it can be attached to the towing vehicle. It's one of many hitch accessories used to make the process of towing a little easier.



## PRODUCT INDEX



## Marine Jack



1BJY-TJ-01  
1BJY-TJ-02

1BJY-TJ-04

1BJY-TJ-06S  
1BJY-TJ-08  
1BJY-TJ-08S  
1BJY-TJ-64

1BJY-TJ-03  
1BJY-TJ-05  
1BJY-TJ-09  
1BJY-TJ-10

JY NO.	Capacity	Travel	Finished	Handle Type	Wheel	Feature
1BJY-TJ-01	1000LBS	10"	Zinc	Side	1*6"	Round,Snap Ring
1BJY-TJ-02	1000LBS	10"	Powder+Zinc	Side	1*6"	Round,Snap Ring
1BJY-TJ-03	1000LBS	10"	Zinc	Side	1*6"	Round,Bolt
1BJY-TJ-04	1000LBS	10"	Powder+Zinc	Top	1*6"	Round,Snap Ring
1BJY-TJ-05	1500LBS	10"	Zinc	Side	1*6"	Round,Bolt
1BJY-TJ-09	1500LBS	10"	Zinc	Side	1*8"	Round,Bolt
1BJY-TJ-10	1500LBS	10"	Zinc	Side	1*8"	Round,Bolt
1BJY-TJ-06	1500LBS	10"	Zinc	Side	2*6"	Round,Snap Ring, Single Wheel Rack
1BJY-TJ-06S	1500LBS	10"	Zinc	Side	2*6"	Round,Bolt, Single Wheel Rack
1BJY-TJ-64	2000LBS	12"	Zinc	Side	2*6"	Round,Bolt, Double Wheel Rack
1BJY-TJ-08	2000LBS	10"	Zinc	Side	2*8"	Round,Bolt, Double Wheel Rack
1BJY-TJ-08S	2000LBS	12"	Zinc	Side	2*8"	Round,Bolt, Double Wheel Rack



# A-Frame Jack



JY NO.	Capacity	Travel	Finished	Handle Type	Wheel/Base	Feature
1BJY-TJ-07	2000LBS	15"	Black	Top	without	Round
1BJY-TJ-07FT	2000LBS	15"	Black	Top	with Foot	Round
1BJY-TJ-07S	2000LBS	15"	Black	Top	2*6" Wheel	Round
1BJY-TJ-24	2000LBS	14"	Black	Top	without	Round
1BJY-TJ-26	5000LBS	15"	Black	Top	without	Round
1BJY-TJ-17	2000LBS	10"	Black	Top	without	Round
1BJY-TJ-18	5000LBS	15"	Black	Top	without	Round
1BJY-TJ-19	2000LBS	15"	Black	Side	without	Round
1BJY-TJ-20	5000LBS	15"	Black	Side	without	Round
1BJY-TJ-28	2000LBS	10"	Grey	/	without	Round
1BJY-TJ-45	5000LBS	15"	Black	Side	without	Round
1BJY-TJ-46	2000LBS	15"	Black	Side	without	Round
1BJY-TJ-48	5000LBS	14"	Black	Side	without	Round



# Swivel Jack



JY NO.	Capacity	Travel	Finished	Handle Type	Feature
1BJY-TJ-11	2000LBS	10"	Black/Zinc	Top	Round
1BJY-TJ-12	2000LBS	15"	Black/Zinc	Top	Round
1BJY-TJ-13	5000LBS	10"	Black/Zinc	Top	Round
1BJY-TJ-14	5000LBS	15"	Black/Zinc	Top	Round
1BJY-TJ-15	2000LBS	10"	Black/Zinc	Top	Round
1BJY-TJ-16	2000LBS	15"	Black/Zinc	Top	Round
1BJY-TJ-21	2000LBS	10"	Black/Zinc	Top	Round
1BJY-TJ-22	2000LBS	15"	Black/Zinc	Top	Round
1BJY-TJ-23	2000LBS	10"	Black/Zinc	Side	Round
1BJY-TJ-30	2000LBS	10"	Black/Zinc	Side	Round
1BJY-TJ-31	2000LBS	15"	Black/Zinc	Side	Square
1BJY-TJ-32	5000LBS	10"	Black/Zinc	Side	Square
1BJY-TJ-33	5000LBS	15"	Black/Zinc	Side	Square
1BJY-TJ-34	7000LBS	15"	Black/Zinc	Side	Square
1BJY-TJ-34S	7000LBS	15"+13"	Black/Zinc	Side	Square



# Swivel Jack



1BJY-TJ-42  
1BJY-TJ-43



1BJY-TJ-49  
1BJY-TJ-50  
1BJY-TJ-51  
1BJY-TJ-52



1BJY-TJ-69  
1BJY-TJ-70  
1BJY-TJ-71  
1BJY-TJ-72

JY NO.	Capacity	Travel	Finished	Handle Type	Feature
1BJY-TJ-42	2000LBS	10"	Zinc	Side	Round
1BJY-TJ-43	2000LBS	15"	Zinc	Side	Round
1BJY-TJ-49	2000LBS	10"	Black	Side	Round
1BJY-TJ-50	2000LBS	15"	Black	Side	Round
1BJY-TJ-51	5000LBS	10"	Black	Side	Round
1BJY-TJ-52	5000LBS	15"	Black	Side	Round
1BJY-TJ-69	2000LBS	10"	Black	Side	Round
1BJY-TJ-70	2000LBS	15"	Black	Side	Round
1BJY-TJ-71	5000LBS	10"	Black	Side	Round
1BJY-TJ-72	5000LBS	15"	Black	Side	Round



# Direct-Weld Square Jack



1BJY-TJ-35  
1BJY-TJ-36



1BJY-TJ-37  
1BJY-TJ-38  
1BJY-TJ-39  
1BJY-TJ-40



1BJY-TJ-54



1BJY-TJ-56



1BJY-TJ-66

JY NO.	Capacity	Travel	Finished	Handle Type	Feature
1BJY-TJ-35	7000LBS	15"+13"	Black	Top	Square
1BJY-TJ-36	7000LBS	15"	Zinc	Top	Square
1BJY-TJ-37	5000LBS	10"	Black	Top	Square
1BJY-TJ-38	5000LBS	15"	Black	Top	Square
1BJY-TJ-39	7000LBS	15"	Black	Top	Square
1BJY-TJ-40	7000LBS	15"+13"	Black	Top	Square
1BJY-TJ-54	7000LBS	15"+13"	Black	Side	Square
1BJY-TJ-55	12000LBS	12.5"+13.5"	Black	Pin-Front	Square
1BJY-TJ-56	12000LBS	12.5"+13.5"	Black	Pin-Side	Square
1BJY-TJ-66	7000LBS	15"+13"	Zinc	Side	Square
1BJY-TJ-67	7000LBS	15"+13"	Zinc	Side	Square, Different Plate





# Electric Jack



1BJY-321



1BJY-322



1BJY-323



1BJY-324

JY NO.	Capacity	Motor	Travel	Finished
1BJY-321	3500LBS	12V	15"	Black
1BJY-322	3500LBS	12V	18"	Black
1BJY-323	3500LBS	12V	18"	Black
1BJY-324	4000LBS	12V	14"+8"	Black+Zinc Pin

# Jockey Wheel



1BJY-326



1BJY-327



1BJY-328



1BJY-WC-01



1BJY-WC-02

JY NO.	Capacity	Travel	Finished	Wheel
1BJY-326	300LBS	200mm	Zinc	6" PVC
1BJY-327	350LBS	200mm	Zinc	8" Iron Wheel
1BJY-328	150LBS	200mm	Zinc	6" PVC

JY NO.	Finished	Diameter
1BJY-WC-01	Zinc	35mm
1BJY-WC-02	Zinc	48mm

# RV Stabilizer Jack



1BJY-LS-01



1BJY-LS-03



1BJY-LS-07



1BJY-LS-02



1BJY-LS-04



1BJY-LS-05

JY NO.	Capacity	Min. Lifting Height	Max. Lifting Height
1BJY-LS-01	5000LBS	19"	47"
1BJY-LS-03	5000LBS	19"	42"
1BJY-LS-04	1000LBS	4-5/8"	8"
1BJY-LS-05	1000LBS	7-5/8"	14"
1BJY-LS-07	5000LBS	22"	48"

JY NO.	Capacity	Extended Height	Retracted Height
1BJY-LS-02	1000LBS	18"	11-1/2"







1BJY-JW-01      1BJY-JW-02      1BJY-JW-03      1BJY-JW-04

JY NO.	Capacity	Type	Wheel
1BJY-JW-01	1200LBS	Single	1*6"
1BJY-JW-02	2000LBS	Double	2*6"
1BJY-JW-03	1200LBS	Single	1*6"
1BJY-JW-04	2000LBS	Double	2*6"

## Trailer Jack Foot



1BJY-JT-05      1BJY-JT-02      1BJY-JT-04      1BJY-JT-07

JY NO.	Capacity	Finished	Diameter	Height
1BJY-JT-01	5000LBS	Zinc	2"	3-1/4"
1BJY-JT-02	5000LBS	Zinc	2"	7-1/2"
1BJY-JT-04	5000LBS	Zinc	2"	2"
1BJY-JT-05	5000LBS	Zinc	2"	12"
1BJY-JT-06	2000LBS	Zinc	2"	1-1/2"
1BJY-JT-07	7000LBS	Zinc	2"*2"	16-8/9"

## Jack Gears



1BJY-JG-01      1BJY-JG-02      1BJY-JG-03      1BJY-JG-04

## Jack Handle



1BJY-JH-01      1BJY-JH-02      1BJY-JH-03      1BJY-JH-04      1BJY-JH-05

1BJY-JH-06      1BJY-JH-07      1BJY-JH-08

## Jack Mounting Bars



1BJY-JMB-01



1BJY-JMB-02



1BJY-JMB-03

## Pipe Mount



1BJY-PM-01  
1BJY-PM-02



1BJY-PM-03

## Jack Bearing



1BJY-JB-01  
1BJY-JB-02  
1BJY-JB-03

## Trailer Jack Support Plate



JY NO.	Width	Depth	Hole Measures	Thickness
1BJY-SP-01	6-3/4" at widest point 3-1/8" at narrowest point	4-1/2"	2-1/3"	3mm
1BJY-SP-02	8-5/16" at widest point 5-1/2" at narrowest point	3-3/4"	2-1/3"	3mm

## Jack Pin



1BJY-JP-01      1BJY-JP-02      1BJY-JP-03      1BJY-JP-04      1BJY-JP-05

## Jack Cap



1BJY-JC-01



1BJY-JC-02



1BJY-JC-03

## Snap Ring



1BJY-JSR-01

## Handle Clip



1BJY-JHC-01

## Lifting Nut



1BJY-JLN-01



# BALL MOUNT

Hitchworks trailer hitch ball mount offers a reliable connection for your vehicle and trailer. Ball mounts are available with 1-1/4", 2", 2-1/2" and 3" shanks. We offer everything from standard to specialized, including adjustable ball mount options. From camping trips to commercial jobs, find the right ball hitch from Hitchworks.



# Trailer Ball Mount

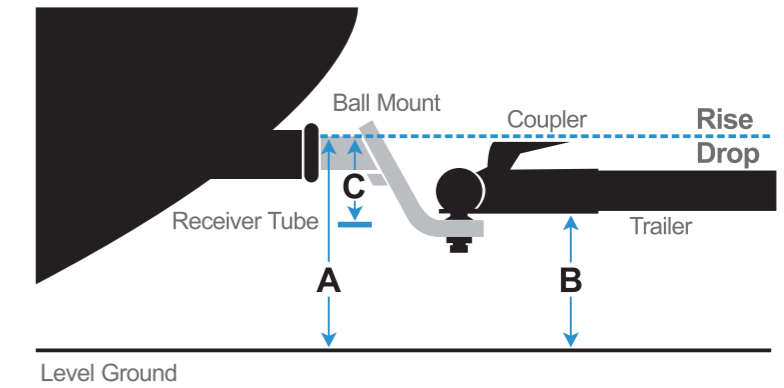

- **A.** The distance is from the top of the receiver tube to the level ground.
- **B.** The distance is from the bottom of the ball platform to the level ground.
- **C.** Drop is the distance the ball platform is set below the top of the shank.
- **Rise** is the distance the ball platform is set above the top of the shank.

JY NO.	Drop	Rise	Shank Length	Receiver Tube	Hole Diameter	Shank	Capacity	Note
1BJY-HM-68	2"	3/4"	8-1/2"	2"*2"	1"	Hollow	5000LBS	Silver
1BJY-HM-69	2"	3/4"	8-1/2"	2"*2"	1"	Hollow	6000LBS	Black
1BJY-HM-70	3"	1-3/4"	8-1/2"	2"*2"	1"	Hollow	6000LBS	Silver
1BJY-HM-71	3"	1-3/4"	8-1/2"	2"*2"	1"	Hollow	6000LBS	Black
1BJY-HM-72	4"	2-3/4"	10-1/4"	2"*2"	1"	Hollow	6000LBS	Silver
1BJY-HM-73	4"	2-3/4"	10-1/4"	2"*2"	1"	Hollow	6000LBS	Black
1BJY-HM-74	5"	3-3/4"	10-1/4"	2"*2"	1"	Hollow	6000LBS	Silver
1BJY-HM-75	5"	3-3/4"	10-1/4"	2"*2"	1"	Hollow	6000LBS	Black
1BJY-HM-07	6"	4-3/4"	10-1/4"	2"*2"	1"	Hollow	7500LBS	Silver
1BJY-HM-76	6"	4-3/4"	10-1/4"	2"*2"	1"	Hollow	7500LBS	Black
1BJY-HM-37	2"	3/4"	8-1/2"	2"*2"	1"	Hollow	6000LBS	Silver
1BJY-HM-38	4"	3/4"	10-1/4"	2"*2"	1"	Hollow	6000LBS	Black

## PRODUCT INDEX



**24**  
TRAILER  
BALL MOUNT



**25-26**  
MULTI-BALL  
MOUNT



**27**  
ALUMINIUM  
ALLOY BALL MOUNT



**28**  
PINTLE  
HOOK



**28**  
PINTLE  
MOUNT



**29**  
RECEIVER  
TUBE



**29**  
TRAILER HITCH  
TIGHTENER





# Multi-Ball Mount



JY NO.	Shank Length	Receiver Tube	Ball Diameter	Shank	GTW	TW	Note
1BJY-HM-23	8"	2**2"	1-7/8"/2"	Hollow	2000/ 6000LBS	200/ 600LBS	Black
1BJY-HM-24	8"	2**2"	2"/2-5/16"	Hollow	6000/ 10000LBS	600/ 1000LBS	Black
1BJY-HM-25	8"	2**2"	1-7/8"/2"	Hollow	2000/ 6000LBS	200/ 600LBS	Silver
1BJY-HM-26	8"	2**2"	2"/2-5/16"	Hollow	6000/ 10000LBS	600/ 1000LBS	Silver
1BJY-HM-30	7"/8.5"	2**2"	1-7/8"/2"/2-5/16"	Hollow	2000/6000/ 10000LBS	200/600/ 1000LBS	Body Black Hitch Ball Silver
1BJY-HM-31	7"/8.5"	2**2"	1-7/8"/2"/2-5/16"	Hollow	2000/6000/ 10000LBS	200/600/ 1000LBS	Zinc
1BJY-HM-32	7"/8.5"	2**2"	1-7/8"/2"/2-5/16"	Hollow	2000/6000/ 10000LBS	200/600/ 1000LBS	Black
1BJY-HM-52	8.5"	2**2"	2"/2-5/16"	Hollow	6000/ 10000LBS	600/ 1000LBS	Black



# Multi-Ball Mount



JY NO.	Shank Length	Receiver Tube	Ball Diameter	Shank	GTW	TW	Note
1BJY-HM-34	7"/8.5"	2**2"	1-7/8"/2"/ 2-5/16"	Hollow	2000/6000/ 10000LBS	200/600/ 1000LBS	Black
1BJY-HM-35	7"/8.5"	2**2"	1-7/8"/2"/ 2-5/16"	Hollow	2000/6000/ 10000LBS	200/600/ 1000LBS	Body Black Hitch Ball Silver
1BJY-HM-57	7"/8.5"	2**2"	1-7/8"/2"/ 2-5/16"	Hollow	2000/6000/ 10000LBS	200/600/ 1000LBS	Red
1BJY-HM-58	8"	2**2"	1-7/8"/2"/ 2-5/16"	Hollow	2000/6000/ 10000LBS	200/600/ 1000LBS	Red
1BJY-HM-59	8"	2**2"	1-7/8"/2"/ 2-5/16"	Hollow	2000/6000/ 10000LBS	200/600/ 1000LBS	Black
1BJY-HM-60	8"	2**2"	1-7/8"/2"/ 2-5/16"	Hollow	2000/6000/ 10000LBS	200/600/ 1000LBS	Body Black Hitch Ball Silver
1BJY-HM-61	8"	2**2"	1-7/8"/2"/ 2-5/16"	Hollow	2000/6000/ 10000LBS	200/600/ 1000LBS	Silver

JY NO.	Drop	Rise	Shank Length	Receiver Tube	Ball Diameter	Shank	GTW	TW	Note
1BJY-HM-22	8"	2"	10.5"	2**2"	1-7/8"/2"	Hollow	2000/ 6000LBS	200/ 600LBS	Black
1BJY-HM-53	8"	2"	10.5"	2**2"	1-7/8"/2"	Hollow	2000/ 6000LBS	200/ 600LBS	Zinc
1BJY-HM-54	8"	2"	10.5"	2**2"	1-7/8"/2"	Hollow	2000/ 6000LBS	200/ 600LBS	Body Black Hitch Ball Silver





# Adjustable Ball Mount

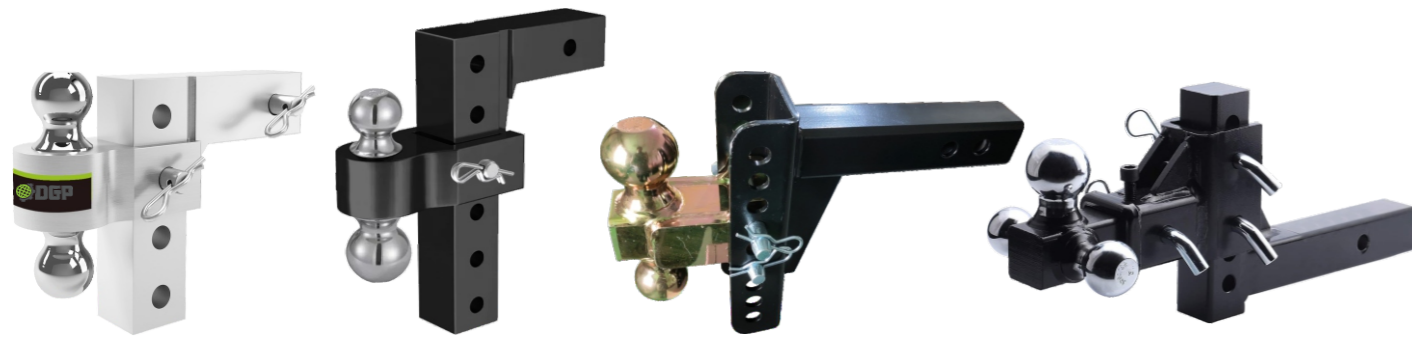

1BJY-HM-44

1BJY-HM-66

1BJY-HM-62

1BJY-HM-67

JY NO.	Drop	Rise	Receiver Tube	Shank Length	Ball Diameter	GTW	TW	Note
1BJY-HM-44	0-6"	0-6"	2" x 2"	12"	2"/2-5/16"	6000/ 10000LBS	600/ 1000LBS	Sliver
1BJY-HM-45	0-6"	0-6"	2" x 2"	12"	2"/2-5/16"	6000/ 10000LBS	600/ 1000LBS	Red
1BJY-HM-46	0-6"	0-6"	2" x 2"	12"	2"/2-5/16"	6000/ 10000LBS	600/ 1000LBS	Black
1BJY-HM-63	0-4"	0-4"	2" x 2"	12"	2"/2-5/16"	6000/ 10000LBS	600/ 1000LBS	Black
1BJY-HM-64	0-6"	0-6"	2" x 2"	12"	2"/2-5/16"	6000/ 10000LBS	600/ 1000LBS	Black
1BJY-HM-65	0-8"	0-8"	2" x 2"	12"	2"/2-5/16"	6000/ 10000LBS	600/ 1000LBS	Black
1BJY-HM-66	0-10"	0-10"	2" x 2"	12"	2"/2-5/16"	6000/ 10000LBS	600/ 1000LBS	Black
1BJY-HM-62	6"	5-1/4"	2" x 2"	17"	2"/2-5/16"	6000/ 10000LBS	600/ 1000LBS	Black
1BJY-HM-67	5-3/4"	4"	2" x 2"	15-1/4"	1-7/8"/2"/ 2-5/16"	2000/6000/ 10000LBS	200/600/ 1000LBS	Black



# Pintle Hook



1BJY-PH-01A



1BJY-PH-02A



1BJY-PH-01B  
1BJY-PH-01C  
1BJY-PH-01D



1BJY-PH-02B  
1BJY-PH-02C  
1BJY-PH-02D

JY NO.	Receiver Tube	Ball Diameter	Capacity
1BJY-PH-01A	2"*2"	No Ball	8T
1BJY-PH-01B	2"*2"	1-7/8"	2000LBS
1BJY-PH-01C	2"*2"	2"	6000LBS
1BJY-PH-01D	2"*2"	2-5/16"	10000LBS
1BJY-PH-02A	2"*2"	No Ball	8T
1BJY-PH-02B	2"*2"	1-7/8"	2000LBS
1BJY-PH-02C	2"*2"	2"	6000LBS
1BJY-PH-02D	2"*2"	2-5/16"	10000LBS

# Pintle Mount



1BJY-HA-14  
1BJY-HA-14S  
1BJY-HA-17



JY NO.	Shank Length	Receiver Tube	Plate Hole	Width	Hitch Pin Hole	Shank	Capacity
1BJY-HA-14	8"	2"*2"	17/32"	3-3/8"	5/8"	Solid	10000LBS
1BJY-HA-14S	12"	2"*2"	17/32"	3-3/8"	5/8"	Solid	10000LBS
1BJY-HA-17	12-1/2"	2"*2"	17/32"	5/8"	5/8"	Solid	10000LBS



# Receiver Tube

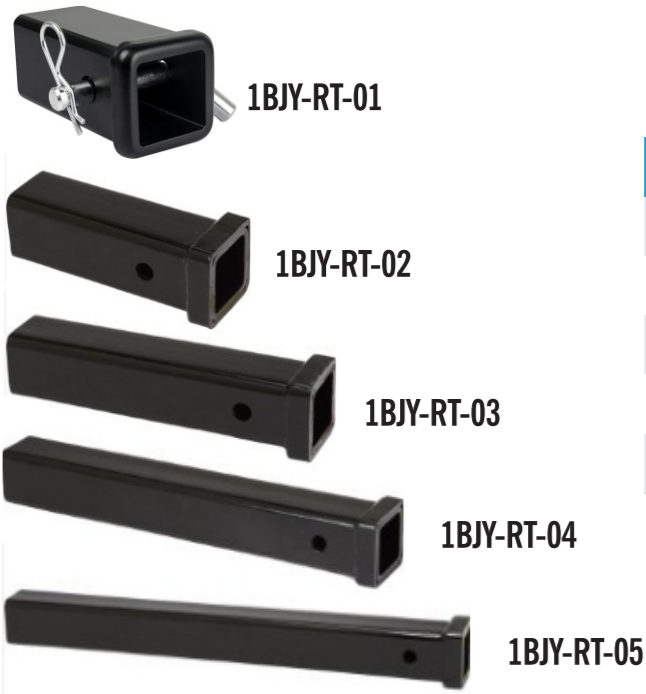

JY NO.	Inner	Length	Hitch Pin Hole	Capacity
1BJY-RT-01	2"*2"	6"	5/8"	10000LBS
1BJY-RT-02	2"*2"	8"	5/8"	10000LBS
1BJY-RT-03	2"*2"	12"	5/8"	10000LBS
1BJY-RT-04	2"*2"	18"	5/8"	10000LBS
1BJY-RT-05	2"*2"	24"	5/8"	10000LBS

## Trailer Hitch Tightener

- Hitch Plate - Carbon Steel - Black Paint - U Bolt - Zinc Plated.
- Perfect for locking 1.25" and 2" hitches, compatible with most hitches classes I, II, III, and IV (1, 2, 3 and 4). Suitable for trailer truck SUV sedan RV camper van and minivan.

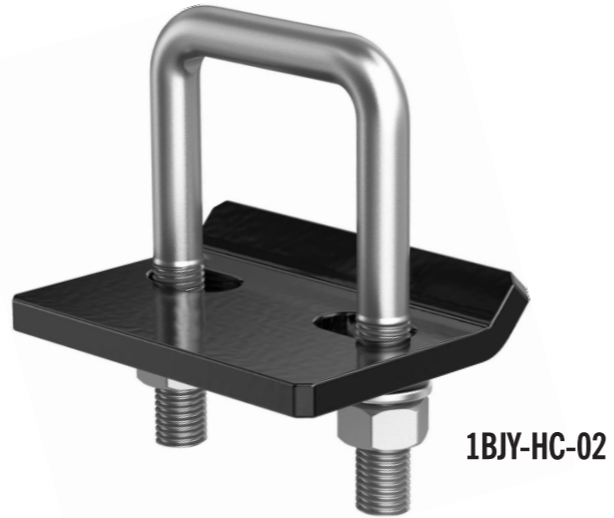

# WINCHES

Hitchworks winches are perfect for adding functionality to your trailer. They are available in 600LB to 16800LB capacities and various sizes. We also provide many specifications of winch straps, as well as cambuckle and ratcheting straps for light and heavy items.



## PRODUCT INDEX



**31**  
HAND  
WINCH



**32**  
ELECTRIC  
WINCH



**32**  
TIE DOWN  
STRAP



# Hand Winch

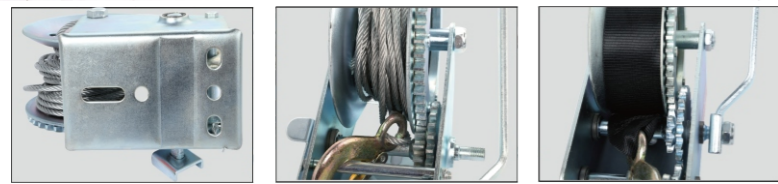
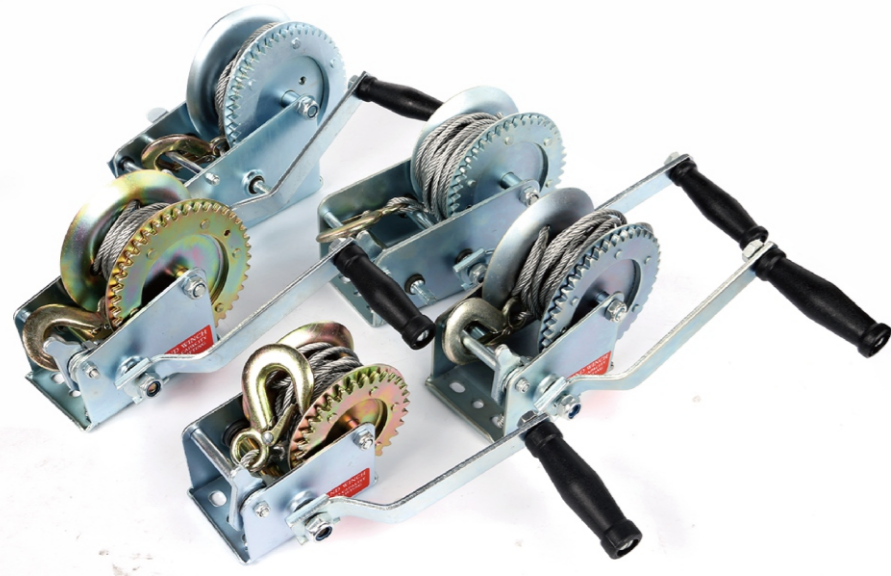

JY NO.	Capacity	Belt Size	Gear Ratio
1BJY-HW-01B	600LBS	6m	3.2:1
1BJY-HW-02B	800LBS	8m	3.2:1
1BJY-HW-03B	1000LBS	7.5m	4:1
1BJY-HW-04B	1200LBS	7m	4:1
1BJY-HW-05B	1400LBS	7m	4:1
1BJY-HW-06B	1600LBS	7m	5:1
1BJY-HW-07B	1800LBS	8m	4:1/8:1
1BJY-HW-08B	2000LBS	8m	4:1/8:1
1BJY-HW-09B	2500LBS	8m	4:1/8:1
1BJY-HW-10B	3000LBS	8m	4:1/8:1
1BJY-HW-11B	3500LBS	10m	4:1/8:1
1BJY-HW-12B	1500LBS	6m	4.1:1
1BJY-HW-13B	3500LBS	10m	4:1/8:1
1BJY-HW-14B	3500LBS	10m	4:1/8:1
1BJY-HW-15B	900LBS	4.5m	4.1:1
1BJY-HW-16B	900LBS	4.5m	3.2:1

JY NO.	Capacity	Gear Ratio
1BJY-HW-01	600LBS	3.2:1
1BJY-HW-02	800LBS	3.2:1
1BJY-HW-03	1000LBS	4:1
1BJY-HW-04	1000LBS	4:1
1BJY-HW-05	1400LBS	4:1
1BJY-HW-06	1600LBS	5:1
1BJY-HW-07	1800LBS	4:1/8:1
1BJY-HW-08	2000LBS	4:1/8:1
1BJY-HW-09	2500LBS	4:1/8:1
1BJY-HW-10	3000LBS	4:1/8:1
1BJY-HW-11	3500LBS	4:1/8:1
1BJY-HW-14	2600LBS	4:1/8:1
1BJY-HW-17	800LBS	3.1:1

JY NO.	Capacity	Steel Wire Size	Gear Ratio
1BJY-HW-01S	600LBS	4.5mmX8m	3.2:1
1BJY-HW-02S	800LBS	4.5mmX8m	3.2:1
1BJY-HW-03S	1000LBS	4.5mmX8m	4:1
1BJY-HW-04S	1200LBS	4.5mmX5m	4:1
1BJY-HW-05S	1400LBS	4.5mmX8m	4:1
1BJY-HW-06S	1600LBS	4.8mmX10m	5:1
1BJY-HW-07S	1800LBS	4.8mmX10m	4:1/8:1
1BJY-HW-08S	2000LBS	4.8mmX10m	4:1/8:1
1BJY-HW-09S	2500LBS	4.8mmX10m	4:1/8:1
1BJY-HW-10S	3000LBS	5.0mmX10m	4:1/8:1
1BJY-HW-11S	3500LBS	6.0mm*10m	4:1/8:1

# Electric Winch



JY NO.	Gear ratio	Mounting Bolt pattern	Capacity	Motor
1BJY-EW-01	265:1	254mm×114.3mm	12000LBS	3.9kw/5.35hp, series wound
1BJY-EW-02	235:1	254mm×114.3mm	8500LBS	3.2kw/4.3hp, permanent magnet
1BJY-EW-03	312.4:1	254mm×114.3mm	16000LBS	12V 5.6hp/4.2kw 24V 6.17hp/4.6kw, series wound
1BJY-EW-04	265:1	255mm×114mm Φ11	9500LBS	3.6kw/4.9hp, permanent magnet
1BJY-EW-05	235:1	255mm×114mm Φ11	8000LBS	3.0kw/4.1hp, permanent magnet
1BJY-EW-06	235:1	165mm×114mm Φ11	6000LBS	2.0kw/2.7hp, permanent magnet
1BJY-EW-07	265:1	255mm*114mm, Ø111B	10000LBS	3.9kw/5.35hp, series wound
1BJY-EW-08	265:1	254mm×114.3mm	13000LBS	4.1kw/5.6hp, series wound
1BJY-EW-09	358:1	254mm×114.3mm	15000LBS	4.0kw/5.4hp, series wound
1BJY-EW-10	358:1	254mm×114.3mm	16800LBS	4.4kw/6.0hp, series wound
1BJY-EW-11	153:1	285mm*105mm	2000LBS	12v/1.0hp permanent magnet
1BJY-EW-12	153:1	285mm*105mm	3000LBS	0.9kw/1.2hp/12v permanent magnet

JY NO.	Size	LC
1BJY-RS-09	25mm x 1.8m	300DAN

JY NO.	Size	Capacity
RTD0012	6' x 2"	3333LBS
RTD0011	10' x 2"	15000LBS



# SAFETY CHAIN

We offer a variety of styles and specifications of safety chains in case your trailer should become uncoupled from your towing setup. Chains are available with either Clevis Slip Hook or Clevis Grab Hook and are available in white or yellow zinc.



# Safety Chain



JY NO.	Chain size	Chain length	S-hook size	Capacity
1BJY-SC-01-100	3/16"	100cm	3/8"	2000LBS
1BJY-SC-02	3/16"	66cm	3/8"	3000LBS
1BJY-SC-02-100	3/16"	100cm	3/8"	3000LBS
1BJY-SC-02A-TWO	3/16"	122cm	3/8"	3000LBS
1BJY-SC-03	1/4"	66cm	7/16"	5000LBS
1BJY-SC-03-100	1/4"	100cm	7/16"	5000LBS
1BJY-SC-03A	1/4"	122cm	7/16"	5000LBS
1BJY-SC-04	5/16"	66cm	17/32"	7000LBS
1BJY-SC-04-100	5/16"	100cm	17/32"	7000LBS
1BJY-SC-04A	5/16"	80cm	7/16"	7000LBS
1BJY-SC-05	3/8"	66cm	17/32"	7000LBS
1BJY-SC-05-100	3/8"	100cm	17/32"	7000LBS
1BJY-SC-05A	3/8"	80cm	17/32"	7000LBS
1BJY-SC-24	3/8"	140cm	7/16"	7000LBS
1BJY-SC-25	3/8"	140cm	17/32"	7000LBS

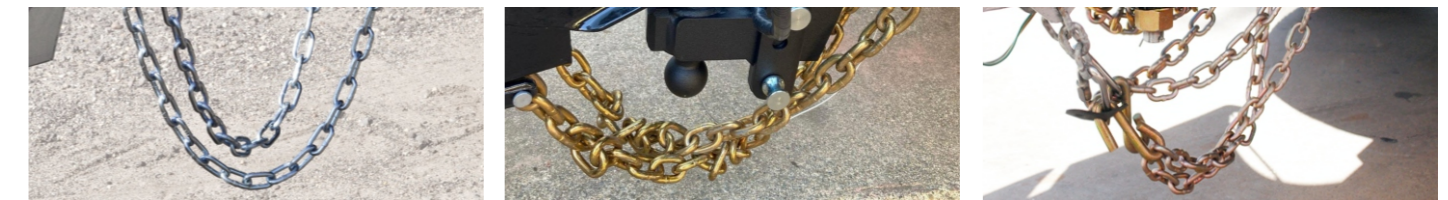

JY NO.	Chain size	Chain length	Chain Grade	Capacity
1BJY-SC-11	1/4"	66cm	G-43 High Test	7800LBS
1BJY-SC-12	5/16"	80cm	G-43 High Test	10800LBS
1BJY-SC-13-100	3/8"	100cm	G-43 High Test	16200LBS
1BJY-SC-13-66	3/8"	66cm	G-43 High Test	16200LBS
1BJY-SC-13L	3/8"	32"	G-70 Transport Chain	16200LBS
1BJY-SC-14	1/4"	66cm	G-70 Transport Chain	12600LBS
1BJY-SC-14L	1/4"	32"	G-70 Transport Chain	12600LBS
1BJY-SC-15	5/16"	66cm	G-70 Transport Chain	18800LBS
1BJY-SC-15A	5/16"	35"	G-70 Transport Chain	18800LBS
1BJY-SC-15L	5/16"	32"	G-70 Transport Chain	18800LBS
1BJY-SC-16	3/8"	66cm	G-70 Transport Chain	26400LBS
1BJY-SC-16A	3/8"	35"	G-70 Transport Chain	26400LBS
1BJY-SC-18	5/16"	35"	G-70 Transport Chain	11700LBS
1BJY-SC-19	3/8"	5/16"	G-70 Transport Chain	18800LBS
1BJY-SC-20	3/8"	3/8"	G-70 Transport Chain	16200LBS
1BJY-SC-21	3/8"	1/4"	G-70 Transport Chain	12600 LBS
1BJY-SC-31	5/16"	20'	G-70 Transport Chain	21.3 KN
1BJY-SC-32	5/16"	14'	G-70 Transport Chain	21.3 KN
1BJY-SC-33	3/8"	20'	G-70 Transport Chain	29.9 KN



## PRODUCT INDEX



**34**  
SAFETY CHAIN



**35**  
CLEVIS SLIP HOOK



**35**  
CLEVIS GRAB HOOK



**35**  
WELD-ON FORGED D RING



### Clevis Slip Hook



### Clevis Grab Hook



### Weld-On Forged D Ring



JY NO.	Size	Class	Color
1BJY-CSH-01	1/2"	G70	Gold/Zinc
1BJY-CSH-02	1/4"	G70	Gold/Zinc
1BJY-CSH-03	7/16"	G70	Gold/Zinc
1BJY-CSH-04	5/8"	G70	Gold/Zinc
1BJY-CSH-05	5/16"	G70	Gold/Zinc
1BJY-CSH-06	3/8"	G70	Gold/Zinc
1BJY-CSH-07	1/2"	G70	Gold/Zinc
1BJY-CSH-08	1/4"	G70	Gold/Zinc
1BJY-CSH-09	7/16"	G70	Gold/Zinc
1BJY-CSH-10	5/8"	G70	Gold/Zinc
1BJY-CSH-11	5/16"	G70	Gold/Zinc
1BJY-CSH-12	3/8"	G70	Gold/Zinc



JY NO.	Description	Diameter	Interior Dimensions	Working Load	Maximum Load
1BJY-DR-01	1" Lashing Ring 3"X4"- Wele on	1"	3**3-1/2**4"	15586LBS	47000LBS
1BJY-DR-02	1" Lashing Ring 3"X4"- Weld On Bulk	1"	3**3-1/2**4"	15586LBS	47000LBS
1BJY-DR-03	1" Lashing W/ 360° Rotation	1"	3**3"	15586LBS	47000LBS
1BJY-DR-04	Forged Ged Lashing Ring 1"-55°	1"	3**3-1/2"	15586LBS	47000LBS
1BJY-DR-05	Forged Ged Lashing Ring 1"-55° Bulk	1"	3**3-1/2"	15586LBS	47000LBS
1BJY-DR-06	Lashing Ring 1" - Weld On	1"	3**3"	15666LBS	47000LBS
1BJY-DR-07	Lashing Ring 1/2" - Weld On	1/2"	2-1/4**2-1/2"	4000LBS	12000LBS
1BJY-DR-08	Lashing Ring 1/2" - Weld On Bulk	1/2"	2-1/4**2-1/2"	4000LBS	12000LBS
1BJY-DR-09	Lashing Ring 1/2"-Bolt On 3/8" Hole	1/2"	/	4000LBS	12000LBS
1BJY-DR-10	Lashing Ring 3/4" - Weld On	3/4"	3**3"	8833LBS	26500LBS
1BJY-DR-11	Lashing Ring 5/8" - Weld On	5/8"	3**3"	6000LBS	18000LBS
1BJY-DR-12	Lashing Ring 5/8" - Weld On Bulk	5/8"	3**3"	6000LBS	18000LBS

## TRAILER HITCH BALL

We offer a variety of styles and specifications of safety chains in case your trailer should become uncoupled from your towing setup. Chains are available with either Clevis Slip Hook or Clevis Grab Hook and are available in white or yellow zinc.



## PRODUCT INDEX



## 37 TRAILER HITCH BALL



# Trailer Hitch Ball



JY NO.	Ball Dia.	Shank Dia.	Shank Length	Capacity	JY NO.	Ball Dia.	Shank Dia.	Shank Length	Capacity
1BJY-HB-01	1-7/8"	3/4"	1-1/2"	2000LBS	1BJY-HB-24	2"	1"	2-1/8"	6000LBS
1BJY-HB-03	1-7/8"	3/4"	1-3/4"	2000LBS	1BJY-HB-26	2"	1"	2-1/8"	6000LBS
1BJY-HB-04	1-7/8"	3/4"	2"	2000LBS	1BJY-HB-27	2"	1"	2-1/2"	6000LBS
1BJY-HB-05	1-7/8"	3/4"	2-5/16"	2000LBS	1BJY-HB-28	2"	1"	2-1/4"	6000LBS
1BJY-HB-06	1-7/8"	3/4"	2-1/2"	2000LBS	1BJY-HB-29	2"	1"	3"	6000LBS
1BJY-HB-07	1-7/8"	3/4"	3"	2000LBS	1BJY-HB-30	2"	1"	2-5/16"	6000LBS
1BJY-HB-08	2"	1"	2.13"	7500LBS	1BJY-HB-32	2"	2-1/4"	2-1/4"	5000LBS
1BJY-HB-09	1-7/8"	1"	2"	3500LBS	1BJY-HB-33	2-5/16"	1"	2"	7500LBS
1BJY-HB-10	1-7/8"	1"	2-1/8"	3500LBS	1BJY-HB-34	2-5/16"	1"	2-1/8"	7500LBS
1BJY-HB-11	2"	1"	5cm	6000LBS	1BJY-HB-35	2-5/16"	1"	2-1/2"	7500LBS
1BJY-HB-12	1-7/8"	1"	2-1/2"	3500LBS	1BJY-HB-36	2-5/16"	1"	3"	7500LBS
1BJY-HB-13	1-7/8"	1"	3"	3500LBS	1BJY-HB-39	2-5/16"	2-1/4"	2-1/2"	10000LBS
1BJY-HB-15	2"	3/4"	1-1/2"	3500LBS	1BJY-HB-46C	50mm	22.5mm	54mm	1.6T
1BJY-HB-16	2"	3/4"	1-3/4"	3500LBS	1BJY-HB-47	50mm	22"	50mm	3.5T
1BJY-HB-17	2"	3/4"	2"	3500LBS	1BJY-HB-48	50mm	22"	54mm	3.5T
1BJY-HB-18	2"	3/4"	2-1/8"	3500LBS	1BJY-HB-49	50mm	22"	65mm	3.5T
1BJY-HB-19	2"	3/4"	2-5/16"	3500LBS	1BJY-HB-50	50mm	7/8"	50mm	3.5T
1BJY-HB-20	2"	3/4"	2-1/2"	3500LBS	1BJY-HB-51	50mm	7/8"	54mm	3.5T
1BJY-HB-21	2"	3/4"	3"	3500LBS	1BJY-HB-52	50mm	7/8"	65mm	3500LBS
1BJY-HB-22	2"	3/4"	2-1/4"	3500LBS	1BJY-HB-53	2"	1"	54mm	7500LBS
1BJY-HB-23	2"	1"	2"	5000LBS	1BJY-HB-54	1-7/8"	5/8"	1-3/4"	2000LBS



# TRAILER LIGHTS

All trailers must have tail lights, turn signals, reflectors and stop lights.



## PRODUCT INDEX



**39**  
TRAILER LIGHT  
KIT



**39**  
STOP/TURN/  
TAIL LIGHTS



**39**  
MARKER CLEARANCE  
LIGHTS



# Trailer Light Kit



1BJY-TL-01



1BJY-TL-02



1BJY-TL-03



1BJY-TL-04

- 12V, LED / 12V, Bulb
- Applicable to All Trailers Over and Under 80" Wide
- Kit Includes: 2 Taillights, 20Ft Wiring Harness With Standard 4-Pin Connector, License Plate Bracket, Mounting Hardware



1BJY-TL-05

- 12V, LED
- 20Ft Wiring Harness With Standard 4-Pin Connectors
- 80" Cord in Between The Lights



1BJY-TL-06

- 6" Oval Led Trailer Tail Lights 10 LED, Rubber Grommets, Wiring Pigtails and 3-way Plug



1BJY-TL-07

- 4" Round Red 12 LED Trailer Lights



1BJY-TL-08

- 6" Oval Trailer Tail Lights Red 6 LED 3 Wires Connection System



1BJY-TL-09

- 16 LED Trailer Tail Light
- 5 Function options (Including Number plate light)



1BJY-TL-10

- 10" 15 LED Trailer Identification Light Working Voltage is DC 9 to 30-volt



1BJY-TL-11

- 2" Sealed LED amber light kit



1BJY-TL-12

- LED 3/4" Red with 2 Wire Leads 8-16 Volt Operating Range

# OTHER TRAILER ACCESSORIES

We have many more trailer accessories available for you.



## PRODUCT INDEX



41  
SPARE TIRE  
CARRIER



41  
RV  
COVER



41  
BOAT  
COVER

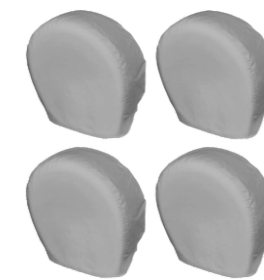

41  
TIRE  
COVER



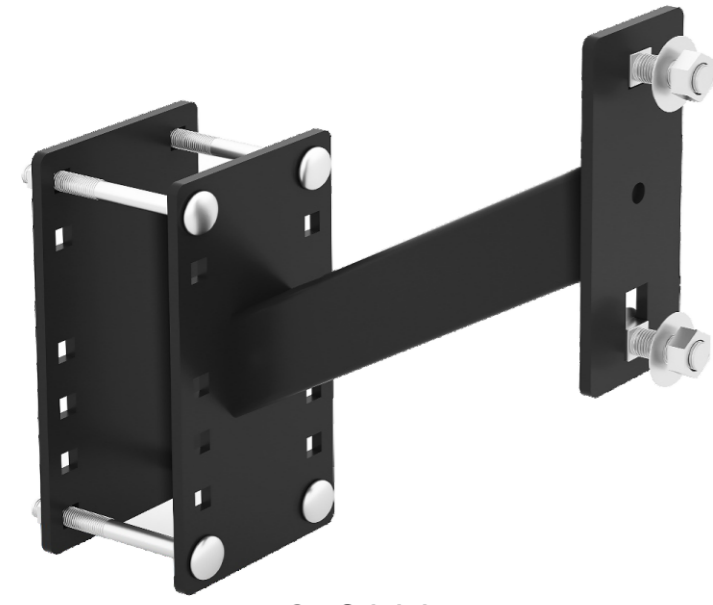

STC0001

Spare Tire Carrier

- Steel, Black powder coating, for 1 tire, with bolts, Universal for kinds of trailer
- Fits 4" & 5" Lugs Wheels.



All Cover Products Support Customization



RV Cover



Boat Cover



Trailer Jack Cover



Tire Cover

Note

HITCHWORKS

HITCHWORKS

HITCHWORKS